

Multi-turn Absolute Rotary Encoder

- External diameter of 50 mm.
- Resolution: Single turn: 500 divisions, Multi-turn: -128 to 127 turns
- Easy origin alignment using origin reset function when building into equipment.
- Need for backup power supply eliminated by multi-turn data storage function.
- Product lineup includes both Solid-shaft and Hollow-shaft Models.



 Be sure to read *Safety Precautions* on page 4.

Ordering Information

Encoders [Refer to *Dimensions* on page 5.]

Shaft	Connection method	Model
Shaft model	Pre-wired Model	E6C-NN5C 2M
Shaft model	Pre-wired Connector Model	E6C-NN5C-C 2M
Hollow shaft	Pre-wired Model	E6C-NN5CA 2M
Hollow shaft	Pre-wired Connector Model	E6C-NN5CA-C 2M

Accessories (Order Separately)

[Dimensions: Refer to *Accessories* for dimensions.]

Name	Model	Remarks
Couplings	E69-C06B	---
	E69-C68B	Different end diameter
	E69-C610B	Different end diameter
	E69-C06M	Metal construction
Flanges	E69-FCA	---
	E69-FCA02	Servo Mounting Bracket E69-2 Servo Mounting Bracket provided.
Servo Mounting Bracket	E69-2	Three brackets in a set.

Refer to *Accessories* for details.

Ratings and Specifications

Item		Model E6C-NN5C E6C-NN5CA	E6C-NN5C-C E6C-NN5CA-C
Power supply voltage		12 VDC -10% to 24 VDC +10%, ripple (p-p): 5% max.	
Current consumption*1		80 mA max.	
Resolution	Single-turn absolute	500 divisions	
	Multi-turn absolute	-128 to 127 turns*2, *3	
Rotational limitation at power failure		±80°*4	
Output	Output code	Binary	
	Alarm output	Counter overflow output*5	
	Output configuration	NPN open-collector output	
	Output capacity	Applied voltage: 30 VDC max. Sink current: 10 mA max. (counter overflow output: 30 mA) Residual voltage: 0.4 V max.	
	Logic	Negative logic	
	Direction	Code increases for CW (when viewed from end of shaft)	
Input	Input signals	Single-turn data reset, multi-turn data reset*6	
	Input current	1 mA max.	
	Input logic	Low active, normally open	
	Input time	100 ms min.	
Maximum response frequency		12.5 kHz	
Rise and fall times of output		1 μs max.*7	
Starting torque		2.9 mN·m max.	
Moment of inertia		1.5 × 10 ⁻⁶ kg·m ² max.	
Shaft loading	Radial	30 N	
	Thrust	20 N	
Maximum permissible speed		1,500 r/min	
Ambient temperature range		Operating: -10 to 55°C (with no icing), Storage: -25 to 65°C (with no icing) *8	
Ambient humidity range		Operating/Storage: 35% to 85% (with no condensation)	
Insulation resistance		20 MΩ min. (at 500 VDC) between current-carrying parts and case	
Dielectric strength		500 VAC, 50/60 Hz for 1 min between current-carrying parts and case	
Vibration resistance		Destruction: 10 to 500 Hz, 150 m/s ² or 2-mm double amplitude for 11 min 3 times each in X, Y, and Z directions	
Shock resistance		Destruction: 1,000 m/s ² 3 times each in X, Y, and Z directions	
Degree of protection		IEC 60529 IP50	
Connection method		Pre-wired Models (Standard cable length: 2 m)	Connector Models (Standard cable length: 2 m)
Material		Case: ABS, Main unit: PPS, Pressboard panel: SUS304, Shaft: SUS420J2	
Weight (packed state)		Approx. 400 g	
Accessories		Instruction manual	

Note: The data outputs will all turn OFF as soon as the main power supply turns OFF. Data is not saved.

*1. An inrush current of approximately 8 A will flow for approximately 6.5 ms when the power is turned ON.

*2. Negative values for multi-turn absolute values are expressed as two's complements (see code at right).

*3. Multi-turn data will change approximately 10 μs after single-turn data. Allow for this when reading data.

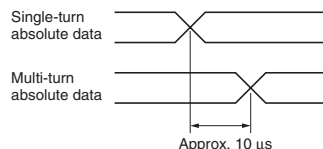

*4. When the power supply is interrupted, multi-turn detection is not performed and multi-turn data is compensated by comparison to the data that existed before the power supply was interrupted. If a rotation operation exceeding ±80° is performed from the position when the main power supply turns OFF, correct multi-turn data will be lost. The application must be set up so that no rotation operations are performed that exceed this stipulation.

*5. Output when the multi-turn counter exceeds the -128 to 127 counting range. This error flag will be reset if the count data returns to within the counting range.

*6. The single-turn data and multi-turn data reset signals can be input independently to reset the single-turn data to address 0 and the multi-turn data to 0 rotations.

*7. Use an Encoder cable length of 10 m max. When using a cable of 10 m or less, read the code 10 μs or more after the LSB (2⁰) of the code changes.

*8. The device coupled to the Encoder shaft must also satisfy the ambient temperature condition.

Multi-turn absolute value code

Multi-turn absolute value	Code
10	0 0 0 0 1 0 1 0
9	0 0 0 0 1 0 0 1
8	0 0 0 0 1 0 0 0
7	0 0 0 0 0 1 1 1
6	0 0 0 0 0 1 1 0
5	0 0 0 0 0 1 0 1
4	0 0 0 0 0 1 0 0
3	0 0 0 0 0 0 1 1
2	0 0 0 0 0 0 1 0
1	0 0 0 0 0 0 0 1
0	0 0 0 0 0 0 0 0
-1	1 1 1 1 1 1 1 1
-2	1 1 1 1 1 1 1 0
-3	1 1 1 1 1 1 0 1
-4	1 1 1 1 1 1 0 0
-5	1 1 1 1 1 0 1 1
-6	1 1 1 1 1 0 1 0
-7	1 1 1 1 1 0 0 1
-8	1 1 1 1 1 0 0 0
-9	1 1 1 1 0 1 1 1
-10	1 1 1 1 0 1 1 0
-11	1 1 1 1 0 1 0 1

The expressions for negative values given above can be achieved by reversing 1's and 0's and then adding 1.

I/O Circuit Diagrams

E6C-NN5C, E6C-NN5CA

E6C-NN5C-C, E6C-NN5CA-C

Input Circuit diagram

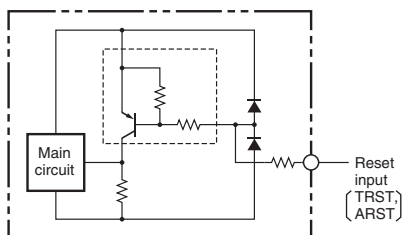

Output Circuit Diagram

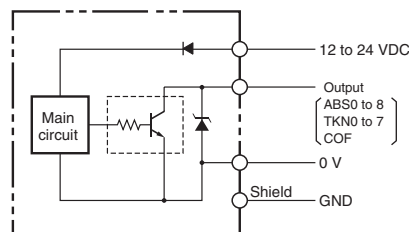

Note: The circuit is the same for all bit outputs.
Each Rotary Encoder has one main circuit.

Output Mode

Direction of rotation: CW (as viewed from end of shaft)

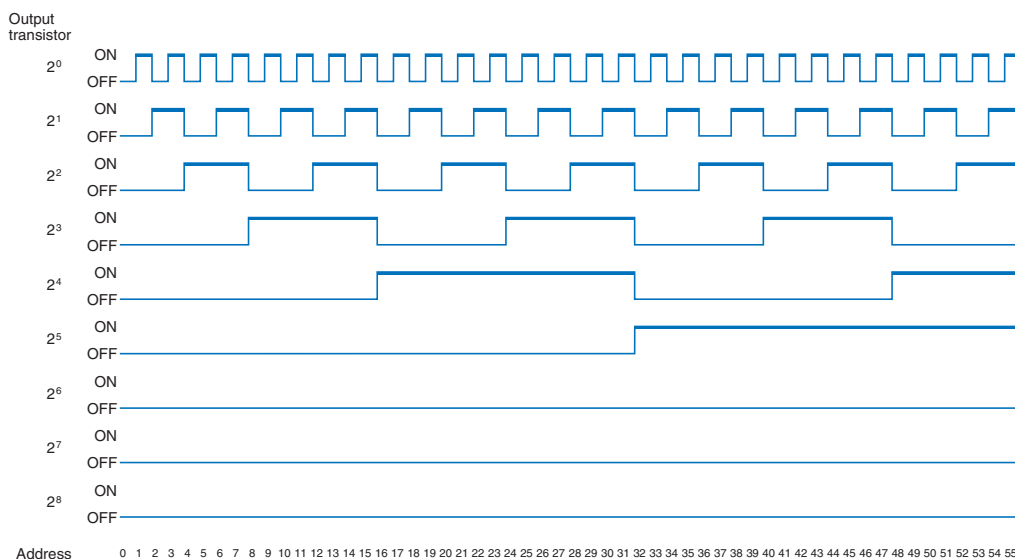

Connections

E6C-NN5C(A)

Wire color: grey			Wire color: Black		
Signal	Meaning	Color	Signal	Meaning	
ABS0	Single-turn absolute data	2 ⁰ Brown	TKN0	Multi-turn absolute data	2 ⁰
ABS1		2 ¹ Orange	TKN1		2 ¹
ABS2		2 ² Yellow	TKN2		2 ²
ABS3		2 ³ Green	TKN3		2 ³
ABS4		2 ⁴ Blue	TKN4		2 ⁴
ABS5		2 ⁵ Purple	TKN5		2 ⁵
ABS6		2 ⁶ Gray	TKN6		2 ⁶
ABS7		2 ⁷ White	TKN7		2 ⁷
ABS8	2 ⁸ Pink	COF	Counter overflow alarm		
ARST	Single-turn data reset	Light blue	TRST	Multi-turn data reset	
GND	0 V*	Black	GND	0 V*	
Vcc	12 to 24 VDC*	Red	Vcc	12 to 24 VDC*	
SHIELD	Shield	—	SHIELD	Shield	

Connections

E6C-NN5C(A)-C

Pin No.	Signal	Meaning	Pin No.	Signal	Meaning		
A1	ABS0	Single-turn absolute data	2 ⁰	B1	TKN0	Multi-turn absolute data	2 ⁰
A2	ABS1		2 ¹	B2	TKN1		2 ¹
A3	ABS2		2 ²	B3	TKN2		2 ²
A4	ABS3		2 ³	B4	TKN3		2 ³
A5	ABS4		2 ⁴	B5	TKN4		2 ⁴
A6	ABS5		2 ⁵	B6	TKN5		2 ⁵
A7	ABS6		2 ⁶	B7	TKN6		2 ⁶
A8	ABS7		2 ⁷	B8	TKN7		2 ⁷
A9	ABS8	2 ⁸	B9	COF	Counter overflow alarm		
A10	ARST	Single-turn data reset	B10	TRST	Multi-turn data reset		
A11	GND	0 V*	B11	GND	0 V*		
A12	Vcc	12 to 24 VDC*	B12	Vcc	12 to 24 VDC*		
A13	SHIELD	Shield	B13	SHIELD	Shield		

* We recommend connecting both Vcc and GND.
Note: Connector Model PS-D4C26 (Hood: PS-HD26) (Japan Aviation Electronics Industry, Ltd.)
Connector: PS-26PE-D4T□-M□ (Straight Model) PS-26PE-D4LT□-M□ (Angle Model) (Japan Aviation Electronics Industry, Ltd.)

Pin Arrangement

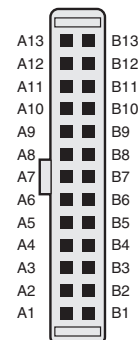

Note: Normally connect GND to 0 V or to an external ground.

Programmable Controller Connection Example

Connection to the CPM1A

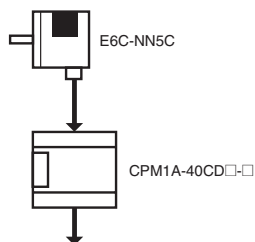

Wiring between the E6C-NN5C and CPM1A

E6C-NN5C output signal		CPM1A input signal	
Single-turn data	Code Cable color: Gray	Brown (2 ⁰)	0 0 0 0 0
		Orange (2 ¹)	0 0 0 0 1
		Yellow (2 ²)	0 0 0 0 2
		Green (2 ³)	0 0 0 0 3
		Blue (2 ⁴)	0 0 0 0 4
		Purple (2 ⁵)	0 0 0 0 5
		Gray (2 ⁶)	0 0 0 0 6
		White (2 ⁷)	0 0 0 0 7
Multi-turn data	Code Cable color: Black	Brown (2 ⁰)	0 0 1 0 0
		Orange (2 ¹)	0 0 1 0 1
		Yellow (2 ²)	0 0 1 0 2
		Green (2 ³)	0 0 1 0 3
		Blue (2 ⁴)	0 0 1 0 4
		Purple (2 ⁵)	0 0 1 0 5
		Gray (2 ⁶)	0 0 1 0 6
Sign + = 0 - = 1		White (2 ⁷)	0 0 1 0 7

Output Timing

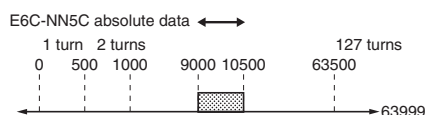

Ladder Programming Example

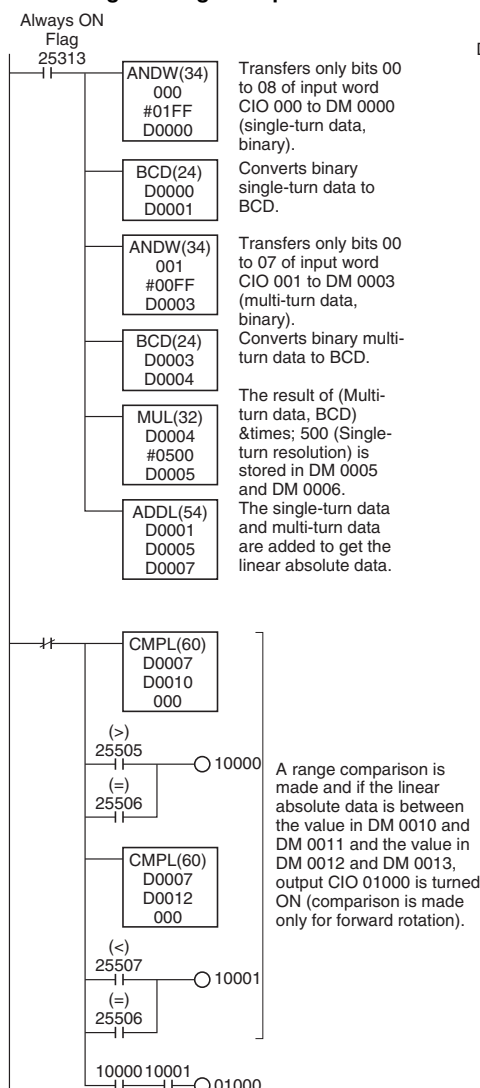

DM Area Settings

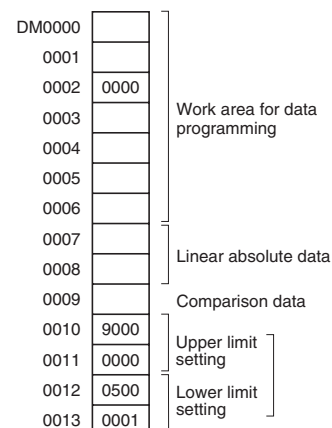

Note: The above ladder programming is only for reference. Data may not always be input properly depending on the data read timing of the Programmable Controller. If data is missed and there is a large difference, e.g., 100 or more, between the current data and the previous data, discard the data the add ladder programmed to re-read the data. (If both the single-turn data and multi-turn data are read at the same time when the multi-turn data changed, the data will be incorrect. Refer to "3" under Ratings and Specifications.

CPM1A For details, refer to the SYSMAC CPM1/CPM1A/CPM2A/CPM2C/SRM1(-V2) Programming Manual (W353).

Safety Precautions

Refer to *Warranty and Limitations of Liability*.

WARNING

This product is not designed or rated for ensuring safety of persons either directly or indirectly. Do not use it for such purposes.



Precautions for Correct Use

Do not use the Encoder under ambient conditions that exceed the ratings.

Wiring

Spurious pulses may be generated when power is turned ON and OFF. Wait at least 0.1 s after turning ON the power to the Encoder before using the connected device, and stop using the connected device at least 0.1 s before turning OFF the power to the Encoder. Also, turn ON the power to the load only after turning ON the power to the Encoder.

Accessories (Order Separately)

Couplings

E69-C06B

E69-C68B

E69-C610B

E69-C06M

Refer to *Accessories* for details.

Flanges

E69-FCA

E69-FCA02

Servo Mounting Bracket

E69-2

Read and Understand This Catalog

Please read and understand this catalog before purchasing the products. Please consult your OMRON representative if you have any questions or comments.

Warranty and Limitations of Liability

WARRANTY

OMRON's exclusive warranty is that the products are free from defects in materials and workmanship for a period of one year (or other period if specified) from date of sale by OMRON.

OMRON MAKES NO WARRANTY OR REPRESENTATION, EXPRESS OR IMPLIED, REGARDING NON-INFRINGEMENT, MERCHANTABILITY, OR FITNESS FOR PARTICULAR PURPOSE OF THE PRODUCTS. ANY BUYER OR USER ACKNOWLEDGES THAT THE BUYER OR USER ALONE HAS DETERMINED THAT THE PRODUCTS WILL SUITABLY MEET THE REQUIREMENTS OF THEIR INTENDED USE. OMRON DISCLAIMS ALL OTHER WARRANTIES, EXPRESS OR IMPLIED.

LIMITATIONS OF LIABILITY

OMRON SHALL NOT BE RESPONSIBLE FOR SPECIAL, INDIRECT, OR CONSEQUENTIAL DAMAGES, LOSS OF PROFITS OR COMMERCIAL LOSS IN ANY WAY CONNECTED WITH THE PRODUCTS, WHETHER SUCH CLAIM IS BASED ON CONTRACT, WARRANTY, NEGLIGENCE, OR STRICT LIABILITY.

In no event shall the responsibility of OMRON for any act exceed the individual price of the product on which liability is asserted.

IN NO EVENT SHALL OMRON BE RESPONSIBLE FOR WARRANTY, REPAIR, OR OTHER CLAIMS REGARDING THE PRODUCTS UNLESS OMRON'S ANALYSIS CONFIRMS THAT THE PRODUCTS WERE PROPERLY HANDLED, STORED, INSTALLED, AND MAINTAINED AND NOT SUBJECT TO CONTAMINATION, ABUSE, MISUSE, OR INAPPROPRIATE MODIFICATION OR REPAIR.

Application Considerations

SUITABILITY FOR USE

OMRON shall not be responsible for conformity with any standards, codes, or regulations that apply to the combination of products in the customer's application or use of the products.

At the customer's request, OMRON will provide applicable third party certification documents identifying ratings and limitations of use that apply to the products. This information by itself is not sufficient for a complete determination of the suitability of the products in combination with the end product, machine, system, or other application or use.

The following are some examples of applications for which particular attention must be given. This is not intended to be an exhaustive list of all possible uses of the products, nor is it intended to imply that the uses listed may be suitable for the products:

- Outdoor use, uses involving potential chemical contamination or electrical interference, or conditions or uses not described in this catalog.
- Nuclear energy control systems, combustion systems, railroad systems, aviation systems, medical equipment, amusement machines, vehicles, safety equipment, and installations subject to separate industry or government regulations.
- Systems, machines, and equipment that could present a risk to life or property.

Please know and observe all prohibitions of use applicable to the products.

NEVER USE THE PRODUCTS FOR AN APPLICATION INVOLVING SERIOUS RISK TO LIFE OR PROPERTY WITHOUT ENSURING THAT THE SYSTEM AS A WHOLE HAS BEEN DESIGNED TO ADDRESS THE RISKS, AND THAT THE OMRON PRODUCTS ARE PROPERLY RATED AND INSTALLED FOR THE INTENDED USE WITHIN THE OVERALL EQUIPMENT OR SYSTEM.

PROGRAMMABLE PRODUCTS

OMRON shall not be responsible for the user's programming of a programmable product, or any consequence thereof.

Disclaimers

CHANGE IN SPECIFICATIONS

Product specifications and accessories may be changed at any time based on improvements and other reasons.

It is our practice to change model numbers when published ratings or features are changed, or when significant construction changes are made. However, some specifications of the products may be changed without any notice. When in doubt, special model numbers may be assigned to fix or establish key specifications for your application on your request. Please consult with your OMRON representative at any time to confirm actual specifications of purchased products.

DIMENSIONS AND WEIGHTS

Dimensions and weights are nominal and are not to be used for manufacturing purposes, even when tolerances are shown.

PERFORMANCE DATA

Performance data given in this catalog is provided as a guide for the user in determining suitability and does not constitute a warranty. It may represent the result of OMRON's test conditions, and the users must correlate it to actual application requirements. Actual performance is subject to the OMRON Warranty and Limitations of Liability.

ERRORS AND OMISSIONS

The information in this document has been carefully checked and is believed to be accurate; however, no responsibility is assumed for clerical, typographical, or proofreading errors, or omissions.

2010.11

In the interest of product improvement, specifications are subject to change without notice.

OMRON Corporation
Industrial Automation Company

<http://www.ia.omron.com/>

(c)Copyright OMRON Corporation 2010 All Right Reserved.